

THUNDERBOLT® PRO



ICCONS®
Serious Connections®

SCREWBOLT ANCHOR

TDS | 1032.6



NO EXPANSION FORCES

5 | 6 | 8 | 10 | 12 | 14 | 18MM

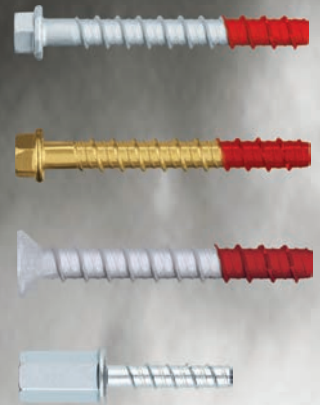

NEXT GENERATION





THUNDERBOLT® PRO HEX HEAD

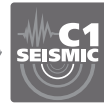
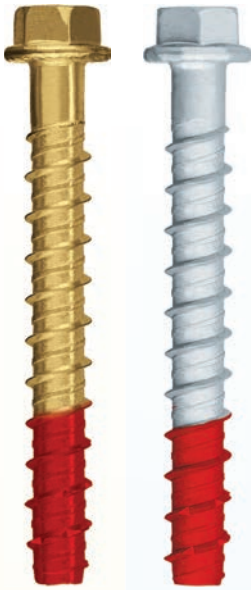

FEATURES & BENEFITS

- Optimum high-performance concrete and masonry screwbolt anchor
- AS 5216:2021 compliant
- ETA assessed for cracked concrete and fire performance
- Flanged hex head design with "lightning bolt" locking serrations for a secure fix
- Also available in CSK and Internal thread head designs
- Stamped head markings for easy identification and traceability
- Zinc and corrosion resistant Nautilus® C coating options
- Fast installation at reduced torque
- No expansion, ideal for close to edge applications
- Suitable for installation with impact drivers
- Removable
- Available on ICCONS Designfix software

APPLICATIONS

- Structural fixings in cracked and uncracked concrete.
- Glazing, windows and storefronts
- Racking and shelving
- Attaching railings, handrails and balustrades
- Fixings wood structures in concrete.

ETA 20/0902-Option 1

ETA 20/0901 (RNSS)

RNSS = Redundant Non-Structural Systems

ZINC YELLOW Part No.	NAUTILUS® C Part No.	Description	Drill Diameter (mm)	Min. Anchor Embedment (mm)	Drill Depth (mm)	Clearance Hole in Fixture (mm)	Max. Fixture Thickness (mm)	Head / Socket Size (mm)	*Max. Impact Tool Torque T _{max} (Nm)	ETA Option	SEISMIC ASSESSMENT C1	SEISMIC ASSESSMENT C2	qty	qty
SXTB05050	SXTB05050G	5 x 50mm	5	35	45	8	15	8	250	RNSS			100	1600
SXTB06040	SXTB06040G	6 x 40mm	6	35	45	9	5	10	250	Option 1 & RNSS	C1		100	1200
SXTB06050	SXTB06050G	6 x 50mm					15						100	1200
SXTB06075	SXTB06075G	6 x 75mm		20	100		600							
SXTB06100	SXTB06100G	6 x 100mm		45	100		600							
SXTB08055	SXTB08055G	8 x 55mm	8	50	60	12	5	13	250	Option 1	C1	C2	100	600
SXTB08060	SXTB08060G	8 x 60mm					10						100	600
SXTB08075	SXTB08075G	8 x 75mm		25	100		400							
SXTB08100	SXTB08100G	8 x 100mm		35	100		400							
	SXTB08130G*	8 x 130mm		65	75		65						100	400
SXTB10060	SXTB10060G	10 x 60mm	10	55	65	14	5	17	250	Option 1			50	300
SXTB10075	SXTB10075G	10 x 75mm					20						50	300
SXTB10100	SXTB10100G	10 x 100mm		15	50		200							
SXTB10120	SXTB10120G	10 x 120mm		35	50		200							
SXTB12080	SXTB12080G	12 x 80mm	12	75	90	16	5	19	600	Option 1			50	200
SXTB12100	SXTB12100G	12 x 100mm					25						50	100
SXTB12120	SXTB12120G	12 x 120mm		15	25		150							
SXTB12150	SXTB12150G	12 x 150mm		45	25		100							
SXTB14080	SXTB14080G	14 x 80mm	14	75	90	18	5	21	600	Option 1			25	150
SXTB14100	SXTB14100G	14 x 100mm					25						25	150
SXTB14130	SXTB14130G	14 x 130mm		15	25		100							
SXTB14150	SXTB14150G	14 x 150mm		35	25		100							
SXTB16100	SXTB16100G	16 x 100mm	16	90	110	19	10	24	600	Pending			15	90
SXTB16150	SXTB16150G	16 x 150mm					60						15	60
SXTB18100	SXTB18100G	18 x 100mm	18	90	110	22	10	26	600	Option 1			20	80
SXTB18150	SXTB18150G	18 x 150mm					10						15	60
SXTB18170	SXTB18170G	18 x 170mm		30	15		60							
SXTB18200	SXTB18200G	18 x 200mm		60	10		40							

* Max. power output of impact screw gun | RNSS = ETA Redundant Non Structural System | Option 1 = ETA Option 1 = AS 5216 Compliant

Excessive torque during installation may damage the anchor. Training, expertise and good judgement is required. Always adhere to anchor installation max. impact torque tool settings.

C1 Seismic assessment only valid for the following embedment depths: Anchor size 6 - 55mm / Anchor size 8 - 50mm & 65mm / Anchor size 10 - 85mm / Anchor size 12 - 105mm / Anchor size 14 - 115mm / Anchor size 18 - 140mm

C2 Seismic assessment only valid for the following embedment depths: Anchor size 8 - 50mm & 65mm / Anchor size 10 - 85mm / Anchor size 12 - 105mm / Anchor size 14 - 115mm / Anchor size 18 - 140mm

ETA assessment pending

* Available in New Zealand



THUNDERBOLT® PRO COUNTERSUNK HEAD

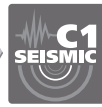

NAUTILUS® C Part No.	Description	Drill Diameter (mm)	Min. Anchor Embedment (mm)	Min. Drill Depth (mm)	Max Fixture Thickness (mm)	Dia. of CSK Drill Size (mm)	CSK Head Height (mm)	Drive Type (Torx)	*Max. Impact Tool Torque T _{max} (Nm)	ETA Option	SEISMIC ASSESSMENT C1 C2	qty	qty
SXTBCS06050G	6 x 50mm	6	35	45	15	15	4.5	T30	250	Option 1 & RNSS		100	1200
SXTBCS06075G	6 x 75mm		55	65	20						C1	100	600
SXTBCS08060G	8 x 60mm	8	50	60	10	21	6.5	T45	250	Option 1		100	600
SXTBCS08075G	8 x 75mm				25						100	400	
SXTBCS08100G	8 x 100mm				50						100	400	
SXTBCS10065G	10 x 65mm	10	55	65	10	24.5	7.3	T50	250	Option 1		50	200
SXTBCS10075G	10 x 75mm				20						50	200	
SXTBCS10100G	10 x 100mm				15						50	200	
SXTBCS12085G	12 x 85mm	12	75	90	10	28	8	T55	600	Option 1		50	200
SXTBCS12100G	12 x 100mm				25						50	200	
SXTBCS12150G	12 x 150mm				45						20	120	

RNSS = ETA Redundant non-structural systems | Option 1 = ETA Option 1 = AS 5216 Compliant

* Max. power output of impact screw gun

Excessive torque during installation may damage the anchor. Training, expertise and good judgement is required. Always adhere to anchor installation max. impact torque tool settings.

C1 Seismic assessment only valid for the following embedment depths: Anchor size 6 - 55mm / Anchor size 8 - 50mm & 65mm / Anchor size 10 - 85mm / Anchor size 12 - 105mm

C2 Seismic assessment only valid for the following embedment depths: Anchor size 8 - 50mm & 65mm / Anchor size 10 - 85mm / Anchor size 12 - 105mm

THUNDERBOLT® PRO ROD HANGERZ™

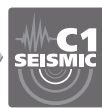

ZINC CLEAR Part No.	Description	Drill Diameter (mm)	Min. Drill Depth (mm)	Min. Anchor Embedment (mm)	Head Socket Size (mm)	Internal Thread (metric)	*Max. Impact Tool Torque T _{max} (Nm)	ETA Option	SEISMIC ASSESSMENT C1 C2	qty	qty
SXTB-IM0635	6 X 35 ETA Rod Hanger (M8/M10)	6	45	35	13	M8/M10	250	Option 1 & RNSS		50	200
SXTB-IM0655	6 X 55 ETA Rod Hanger (M8/M10)		65	55					C1	50	200
SXTB-IM0635-BK	6 X 35 ETA Rod Hanger (M8/M10) Bucket		45	35				Option 1 & RNSS		500	n/a
SXTB-IM0655-BK	6 X 55 ETA Rod Hanger (M8/M10) Bucket		65	55					C1	500	n/a

RNSS = ETA Redundant non-structural systems | Option 1 = ETA Option 1 = AS 5216 Compliant

Excessive torque during installation may damage the anchor. Training, expertise and good judgement is required. Always adhere to anchor installation max. impact torque tool settings.

C1 Seismic assessment only valid for the following embedment depths: Anchor size 6 - 55mm

RANGE IDENTIFICATION

Code	Size	Description	Material
SXTB _____	Ø5 - Ø18	Hexagonal head with flange screw anchor	Carbon Steel Zinc Yellow Coating ≥ 5 µm plus Red Tip
SXTB _____ G	Ø5 - Ø18	Hexagonal head with flange screw anchor	Carbon Steel NAUTILUS®C Coating plus Red Tip
SXTBCS _____ G	Ø6 - Ø12	Countersunk screw anchor	Carbon Steel NAUTILUS®C Coating plus Red Tip
SXTB-IM _____	Ø6	Rod hanger internal thread screw anchor	Carbon steel, zinc plated coating ≥ 5 µm

ICCONS Nautilus® C corrosion resistant coating

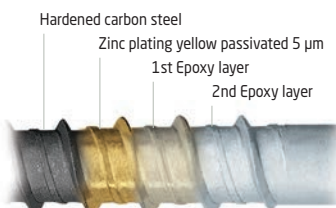

Nautilus® C corrosion resistant coating is a multi layered corrosion resistant coating designed for indoor applications as well as outdoor applications based on urban and industrial atmospheres, moderate sulfur dioxide pollution and coastal areas with low salinity. This is typically covered in EN ISO 12944-2, corrosivity category environment C3 and durability range HIGH according to EN ISO 12944-1. Under these conditions the Nautilus® C coating offers a typical minimum life expectancy of between 15 to 25 yrs. This information is based on testing in accordance with EN ISO 12944.6 and provides average life expectancy data for typical applications. The final decision on coating suitability should be made by the customer/design professional responsible for the application and based on local specific environmental conditions.

INSTALLATION DATA FOR THUNDERBOLT® PRO

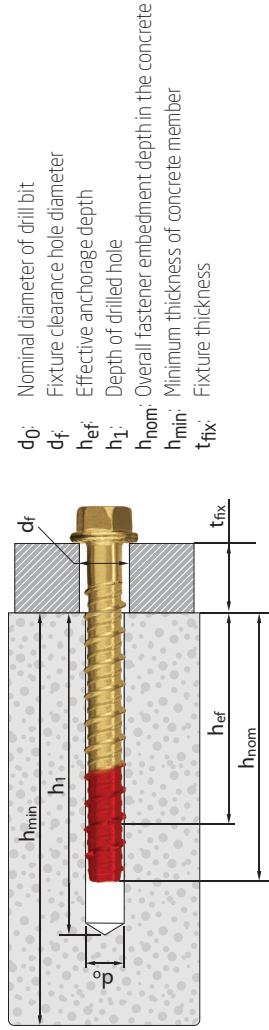
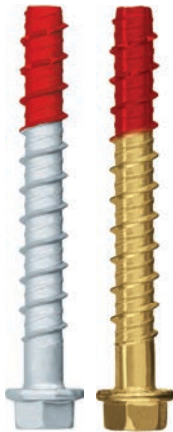

Thunderbolt® Pro Part No	Size [-]	Assessed ETA	Drill bit diameter d ₀ (mm)	Fixture clearance hole df (mm)	Spanner Sw/Tx [-]	Impact tool torque T _{max} [Nm]	Minimum allowable spacing S _{min} (mm)	Minimum allowable edge distance S _{min} (mm)	Standard Installation depth (h _{ef, std})								Reduced Installation depth (h _{ef, red})											
									h ₁ (mm)	h _{nom} (mm)	Effective anchorage depth h _{ef} (mm)	t _{fix} (mm)	S _{CrN} (mm)	C _{CrN} (mm)	S _{CrN} (mm)	C _{CrN} (mm)	S _{CrN} (mm)	C _{CrN} (mm)	S _{CrN} (mm)	C _{CrN} (mm)	S _{CrN} (mm)	C _{CrN} (mm)	S _{CrN} (mm)	C _{CrN} (mm)				
SXTB05050/G	Ø5 x 50	RNSS ✓	5	8	SW 8	250	35	35	100	50	45	350	5	105	53	53	105	53	80	45	35	26.5	15	80	40	40	80	40
SXTB06040/G	Ø6 x 40	✓			SW 10																		5					
SXTB06050/G	Ø6 x 50	✓	6	9	SW 10	250	35	35															15	78	39	90	45	
SXTB06075/G	Ø6 x 75	✓			SW 10				100	65	55	430	20	129	65	65	170	85	100	100	45	35	260	40				
SXTB06100/G	Ø6 x 100	✓			SW 10							45	45										65					
SXTB08055/G	Ø8 x 55	✓			SW 13																		5					
SXTB08060/G	Ø8 x 60	✓			SW 13																		10					
SXTB08075/G	Ø8 x 75	✓	8	12	SW 13	250	35	35	100	75	65	505	10	152	76	200	100	100	100	60	50	37.5	25	113	57	130	65	
SXTB08100/G	Ø8 x 100	✓			SW 13								35										50					
SXTB08130/G*	Ø8 x 130	✓			SW 13								65										80					
SXTB10060/G	Ø10 x 60	✓			SW 17																		5					
SXTB10070/G	Ø10 x 70	✓			SW 17																		15					
SXTB10075/G	Ø10 x 75	✓	10	14	SW 17	250	50	40															20	125	63	140	70	
SXTB10100/G	Ø10 x 100	✓			SW 17				135	95	85	670	15	201	101	210	105						65					
SXTB10120/G	Ø10 x 120	✓			SW 17							35	35										85					

Note: Add "G" to the part no for Nautilus® Capeton. e.g. SXTB05050G. RNSS = Redundant Non-Structural Systems.
* Available New Zealand only

INSTALLATION DATA FOR THUNDERBOLT® PRO ZINC PLATED

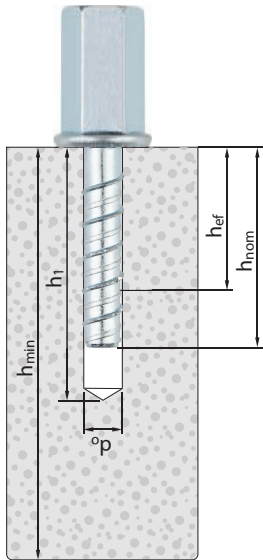

d_0 : Nominal diameter of drill bit
 h_{ef} : Effective anchorage depth
 h_1 : Depth of drilled hole
 h_{nom} : Overall fastener embedment depth in the concrete
 h_{min} : Minimum thickness of concrete member

Thunderbolt® PRO		General Installation parameters										Standard Installation depth ($h_{ef, std}$)										Reduced Installation depth ($h_{ef, red}$)									
		Part No	Size	ETA Assessed	d_0 (mm)	Drill bit diameter	Spanner	T_{max} (Nm)	Impact tool torque	S_{min} (mm)	Minimum allowable spacing	C_{min} (mm)	Minimum allowable edge distance	h_{min} (mm)	Minimum concrete thickness	h_1 (mm)	Depth of drill hole	h_{nom} (mm)	Installation depth	h_{ef} (mm)	Effective anchorage depth	$S_{cr,N}$ (mm)	Critical spacing (concrete cone)	$C_{cr,N}$ (mm)	Critical edge distance (cone)	$S_{cr,sp}$ (mm)	Critical spacing (splitting)	$C_{cr,sp}$ (mm)	Critical edge distance (splitting)		
SXTB-IM0635	Ø6 x 35 (M8-M10)	✓	6	SW 13	250	35	35	35	35	35	35	100	45	35	260	78	39	90	45	100	45	35	260	78	39	90	45	100	45		
SXTB-IM0655	Ø6 x 55 (M8-M10)	✓	6	SW 13	250	35	35	35	35	35	35	100	65	55	430	129	65	65	55	430	129	65	65	65	65	170	85	100	65		



THUNDERBOLT® PRO Performance in accordance with AS 5216

Parameters: Qualification based on AS 5216

Concrete: 20 MPa

Conditions: Single anchor, no edge distance, min recommended concrete thickness

THUNDERBOLT® PRO

Design Resistance Capacities - 20 MPa

Diameter	Installation Depth h_{nom} (mm)	Effective Depth h_{ef} (mm)	Uncracked concrete Tension N_{Rd} (kN)	Cracked concrete Tension N_{Rd} (kN)	Uncracked Concrete Shear V_{Rd} (kN)	Cracked concrete Shear V_{Rd} (kN)
6	35	26.0	2.78	2.54	8.35	6.24
	55	43.0	9.25	6.47	8.35	7.44
8	50	37.5	6.28	4.39	13.05	9.49
	65	50.5	11.77	8.24	13.05	10.46
10	55	41.5	8.77	6.14	17.10	11.97
	75	58.5	14.67	10.27	18.27	13.56
	85	67.0	17.99	12.59	18.27	18.27
12	75	58.0	14.49	10.14	24.83	23.63
	105	83.5	25.02	17.52	24.83	24.83
14	75	58.0	14.49	10.14	35.15	25.86
	115	92.0	28.94	20.26	35.15	35.15
18	90	69.5	19.00	13.30	50.54	35.38
	140	112.0	38.87	27.21	53.85	53.85

Information presented in the above table has been derived from the product ETA (ETA 20/0902) and in accordance with AS 5216:2021. Data is based on single anchor with no edge or spacing influence. For detailed calculations incorporating multiple anchors please download the ICCONS anchor software program for assistance, this download is available via the ICCONS website www.iccons.com.au

THUNDERBOLT® PRO Performance for use in redundant non-structural systems

Design Resistance Capacities - 20 MPa

Diameter	Installation Depth h_{nom} (mm)	Effective Depth h_{ef} (mm)	Uncracked concrete Tension N_{Rd} (kN)	Cracked concrete Tension N_{Rd} (kN)	Uncracked Concrete Shear V_{Rd} (kN)	Cracked concrete Shear V_{Rd} (kN)
5	35	26.5	4.47	3.13	4.47	3.13
	45	35.0	6.79	4.75	5.46	4.75
6	35	26.0	3.62	2.54	4.35	3.04
	55	43.0	9.25	6.47	8.35	6.47

Information presented in the above table has been derived from the product ETA (ETA 20/0901) and in accordance with AS 5216:2021 for redundant non-structural systems. Redundant non-structural systems incorporate multiple fixings and fixing points please refer to product ETA and AS 5216:2021 for further details.



THUNDERBOLT® PRO Performance for use in redundant non-structural systems - prestressed hollow core slabs (C30/37 to C50/60) Design Resistance Capacities

Diameter d_o	Min. Bottom Flange Thickness d_b (mm)	Effective Depth h_{ef} (mm)	Tension N_{Rd} (kN)	Shear V_{Rd} (kN)
5	25	20.0	2.44	2.44
	30	22.0	2.82	2.82
	40	26.5	3.73	3.73
6	25	20.0	2.44	2.44
	30	22.0	2.82	2.82
	40	26.0	3.62	3.62

Information presented in the above table has been derived from the product ETA (ETA 20/0901) and in accordance with AS 5216:2021 for redundant non-structural systems. Redundant non-structural systems incorporate multiple fixings and fixing points please refer to product ETA and AS 5216:2021 for further details.

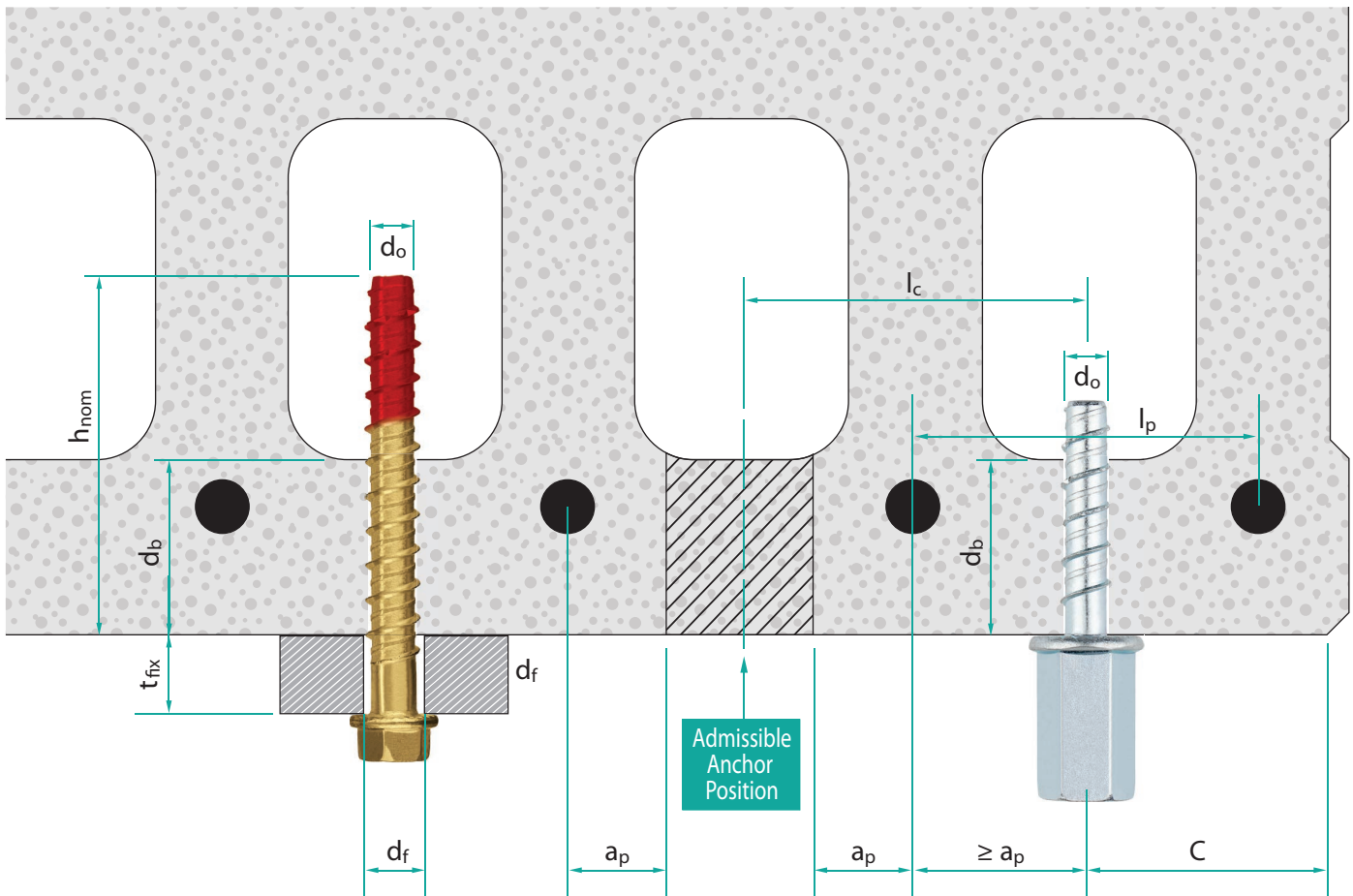

- d_o : Nominal diameter of drill bit
- d_f : Fixture clearance hole diameter
- d_b : Bottom flange thickness
- a_p : Distance between anchor position and prestressing steel ≥ 50 mm
- l_c : Core spacing distance ≥ 100 mm
- l_p : Steel reinforcement spacing distance ≥ 100 mm
- t_{fix} : Fixture thickness
- C: Edge distance



THUNDERBOLT® PRO SXTB Seismic Performance in accordance with AS 5216:2021

THUNDERBOLT® PRO Seismic C1

Design Resistance Capacities (Uncracked & cracked concrete)- 20 MPa ($a_{gap} = 1.0$)

SXTB screwbolt size	Embed. Depth (mm)	Effective Depth (min.)	Tension $N_{Rd,seis}$ (kN)	Shear $V_{Rd,seis}$ (kN)
6	55	43.0	3.3	6.3
8	50	37.5	3.4	5.8
8	65	50.5	5.9	7.8
10	85	67.0	9.8	12.8
12	105	83.5	12.1	15.7
14	115	92.0	15.5	21.1
18	140	112.0	23.1	29.4

→ $a_{seis} = 0.85$ for tension

→ $a_{seis} = 0.85$ for shear concrete pryout

THUNDERBOLT® PRO Seismic C2

Design Resistance Capacities (Uncracked & cracked concrete)- 20 MPa ($a_{gap} = 1.0$)

TSM screwbolt size	Embed. Depth (mm)	Effective Depth (min.)	Tension $N_{Rd,seis}$ (kN)	Shear $V_{Rd,seis}$ (kN)
8	50	37.5	1.3	5.6
8	65	50.5	2.3	7.8
10	85	67.0	4.6	12.8
12	105	83.5	7.0	15.7
14	115	92.0	10.2	21.1
18	140	112.0	21.0	29.4

→ $a_{seis} = 0.85$ for tension

→ $a_{seis} = 0.85$ for shear concrete pryout

Information presented in the above tables has been derived from the product ETA (ETA 20/0902) and in accordance with AS 5216:2021. Data is based on single anchor with no edge or spacing influence. For detailed calculations incorporating multiple anchors please download the ICCONS® anchor software program for assistance, this download is available via the ICCONS® website www.iccons.com.au.

INSTALLATION (SOLID CONCRETE)

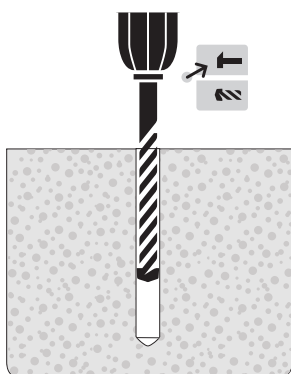

1. Drilling

Check the concrete is well compacted and without significant porosity. Suitable for dry, wet and flooded holes. Use drill in hammer mode. Drill according to specified depths in previous tables.

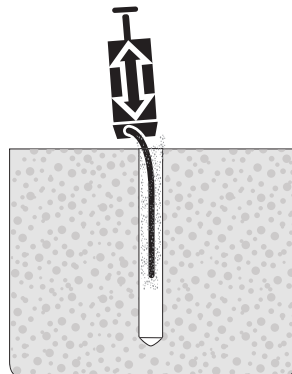

2. Blow and clean

Clean the hole from dust and concrete remains. Use blow pump and brush.

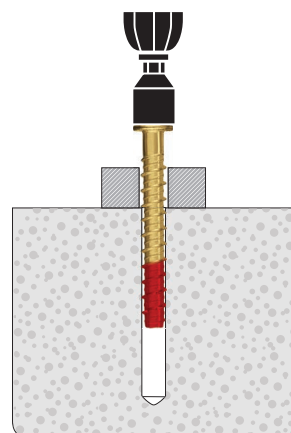

3. Install

Select a powered impact wrench or a torque wrench that does not exceed the maximum torque indicated in previous tables. Attach an appropriate size hex socket to the wrench. Mount the screw anchor head in the socket.

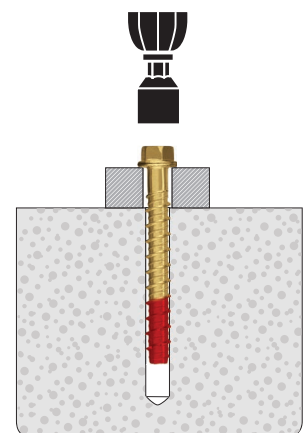

4. Apply torque

Drive the anchor with an impact driver or a torque wrench through the fixture and into the hole until the anchor head washer comes in contact with the fixture. The anchor must be snug after installation. Do not spin the hex socket off the anchor to disengage.



Anchoring

**PURE
EPOXY
GEN³**

Adhesive

ICCONS®



DESIGN FiX[®] anchor design made easy

INCLUDES THE NEW BIS PE GEN3 PURE EPOXY WITH 100 year design service life assessed in accordance with EAD 330499-01-0601

Optimum BIS Injection System anchorage depth

- An innovative 3D visual user interface, utilizing EN 1992-4 design methodology and suitable for design in accordance with AS 5216.
 - Seismic design under earthquake loads according to EN 1992-4, TR 045, TR 049
 - Finite element analysis steel baseplate design
- ICCONS DesignFiX[®] is a simple, intuitive and free to download (registration required) anchor design program for design engineers, project managers, site engineers and end users. Complex mechanical or chemical heavy duty anchor arrangements can be calculated in minutes.

When selecting a BIS Adhesive Injection System, ICCONS DesignFiX allows for the automatic calculation of the most effective anchorage depth, taking into consideration the minimal and maximum values of the ETA.

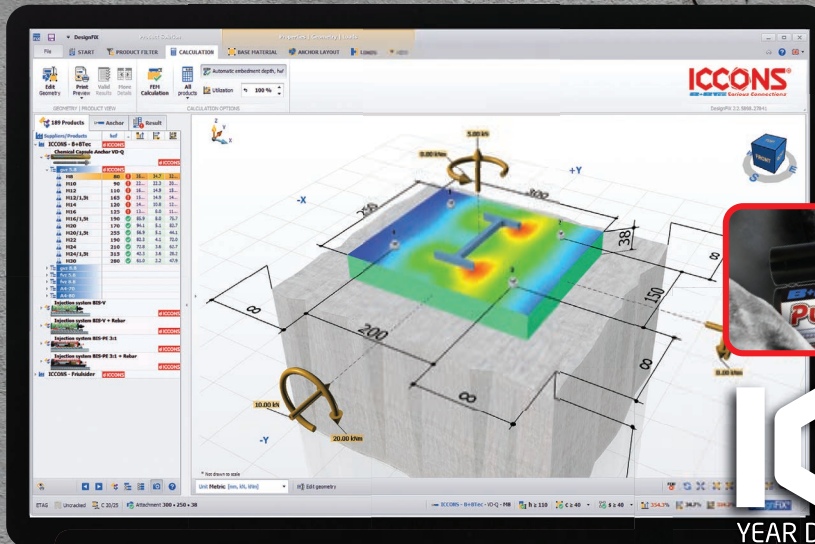

100+
YEAR DESIGN LIFE

FREE DOWNLOAD www.iccons.com.au/software/anchor-design-software

Input freedom & 3D user interface

ICCONS DesignFiX offers complete freedom to select an anchor pattern and base plate configuration, as well as the position and direction of load combinations. Changes are made directly into the 3D user interface.

Anchor type comparison

ICCONS DesignFiX displays the usability of the various anchor types (according to EN 1992-4) including the values for each load type. This allows you to compare the calculation results of the different anchor types in a single easy to read panel. Design results suitable for use in accordance with AS 5216:2018.

Calculate base plate thickness

The integrated FEM-Calculation Method (Finite Element Method) in ICCONS DesignFiX allows you to calculate the base plate thickness based upon the stresses in the base plate in combination with the base plate configuration.





ICCONS® PTY LTD

VICTORIA - HEAD OFFICE
383 Frankston Dandenong Rd,
Dandenong South,
Vic, 3175
P: **03 9706 4344**

NSW Branch
Unit A, 17 Seddon Street,
Bankstown,
New South Wales, 2200
P: **02 9791 6869**

QLD Branch
42-44 Nealdon Dr
Meadowbrook,
Queensland, 4131
P: **07 3200 6455**

FNQ Branch
41 Corporate Crescent
Garbutt,
Queensland, 4814
P: **07 2111 3453**

S.A Branch
29-31 Weaver Street,
Edwardstown,
South Australia 5039
P: **08 8234 5535**

W.A. Branch
90 Christable Way,
Landsdale,
Western Australia, 6065
P: **08 6305 0008**

NORTHERN TERRITORY
Unit 1, 14 Menmuir Street,
Winnellie,
Northern Territory 0820
P: **08 8947 2758**

NEW ZEALAND

Sesto Fasteners
5E Piermark Road,
Albany, Auckland,
New Zealand 0630
P: **+64 9415 8564**
E: sestofasteners@gmail.com

THAILAND

ICCONS (Thailand) Co. Ltd.
55 Phetkasem 62/3, Bangkhuae,
Bangkok 0160
P: **+ 66 2 801 0764**
F: **+ 66 2 801 0764**
M: **+ 66 8 1 710 8745**
E: icconsthailand@hotmail.com